

パワートランジスタ Power Transistor

EVK33-050

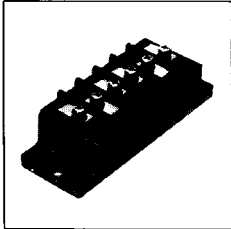

600V
50A
300W

■等価回路図

Equivalent Circuit Schematic

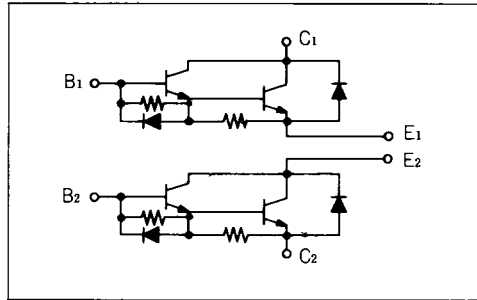

※ Switching Time Test Circuit

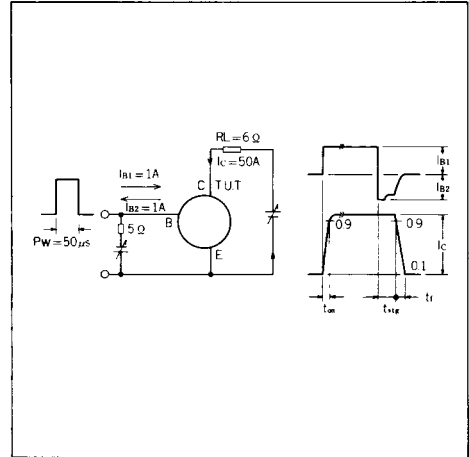

■定格と特性：Maximum Ratings and Characteristics

●絶対最大定格：Absolute Maximum Ratings

Items	Symbols	Rated Values	Units
コレクタ・ベース間電圧	V _{CB0}	600	V
コレクタ・エミッタ間電圧	V _{CE0}	600	V
コレクタ・エミッタ間電圧	V _{CE0(SUS)}	450	V
エミッタ・ベース間電圧	V _{EB0}	6	V
コレクタ電流	DC	I _C	50
	1ms	I _C	100
	DC	-I _C	50
ベース電流	DC	I _B	3
	1ms	I _B	6
コレクタ損失	one Transistor	P _C	300
	two Transistor	P _C	600
接合部温度	T _j	+150	°C
保存温度	T _{stg}	-40~+125	°C
重量	m	235	g
絶縁耐圧	AC.1min	Viso	2000
締付けトルク	Mounting		25±5
	Terminals		M4: 15±2

●電気的特性：Electrical Characteristics (T_j = 25°C)

Items	Symbols	Test Conditions	Min	Typ	Max	Units
コレクタ・ベース間電圧	V _{CB0}	I _{CB0} = 1mA	600			V
コレクタ・エミッタ間電圧	V _{CE0}	I _{CE0} = 1mA	600			V
コレクタ・エミッタ間電圧	V _{CE0(SUS)}	I _C = 1A	450			V
	V _{CEx(SUS)}	I _C = 50A, V _{EB} = 6V, V _{CE} = 500V, I _B = 1A, -I _B = 5A	500			V
エミッタ・ベース間電圧	V _{EB0}	I _{EB0} = 200mA	6			V
コレクタシャ断電流	I _{CB0}	V _{CB0} = 600V			1.0	mA
エミッタシャ断電流	I _{EB0}	V _{EB0} = 6V			200	mA
コレクタ・エミッタ間電圧	-V _{CE}	-I _C = 50A			1.5	V
直流電流増幅率	h _{FE}	I _C = 50A, V _{CE} = 5V	100			
コレクタ・エミッタ飽和電圧	V _{CE(sat)}	I _C = 50A, I _B = 1A			2.0	V
ベース・エミッタ飽和電圧	V _{BE(sat)}				2.5	V
※) スイッチング時間	t _{on}	I _C = 50A, I _{B1} = 1A, -I _{B2} = 1A R _L = 6Ω, P _w = 50μs Duty ≤ 2%			3.0	μs
	t _{stg}				12.0	μs
	t _f				4.0	μs

●熱的特性：Thermal Characteristics

Items	Symbols	Test Conditions	Min	Typ	Max	Units
熱抵抗	R _{th(j-c)}	Transistor			0.41	°C/W
熱抵抗	R _{th(j-c)}	Diode			1.3	°C/W
熱抵抗	R _{th(c-f)}	with Thermal Compound		0.05		°C/W

■特性曲線：Characteristics

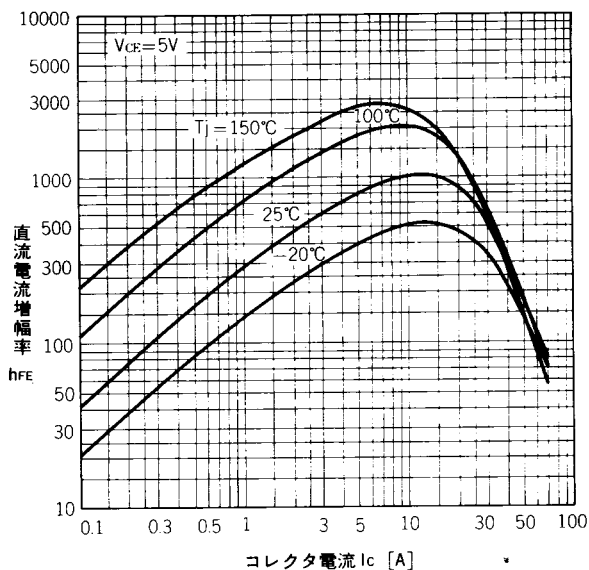

直流電流増幅率—コレクタ電流特性
DC Current Gain

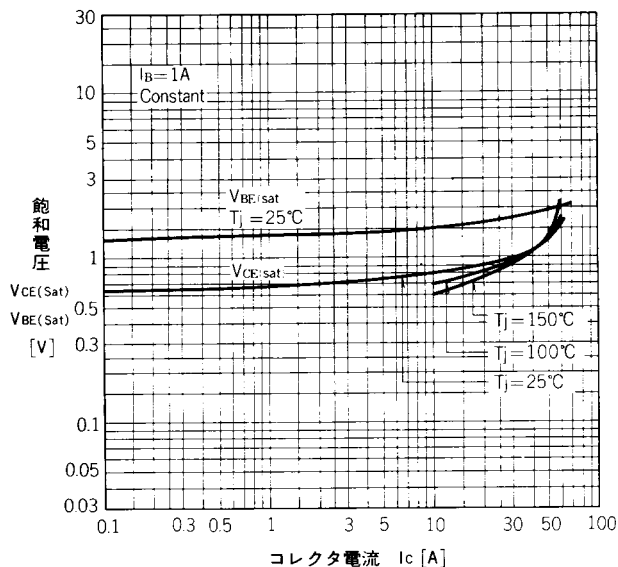

飽和電圧—コレクタ電流特性
Base and Collector Saturation Voltage

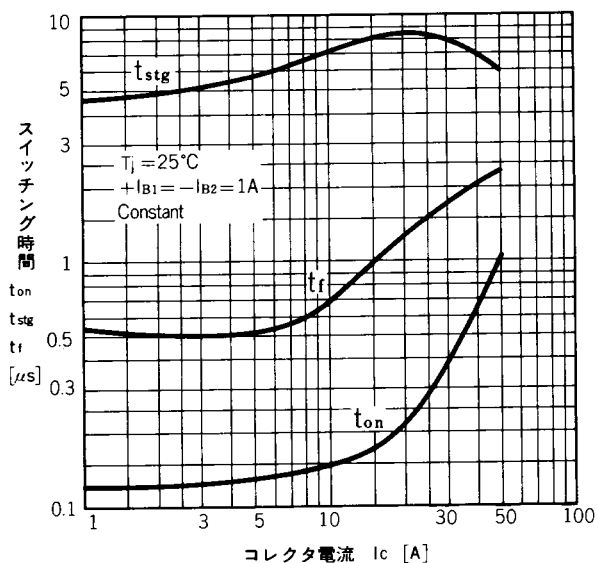

スイッチング時間—コレクタ電流特性
Switching Time

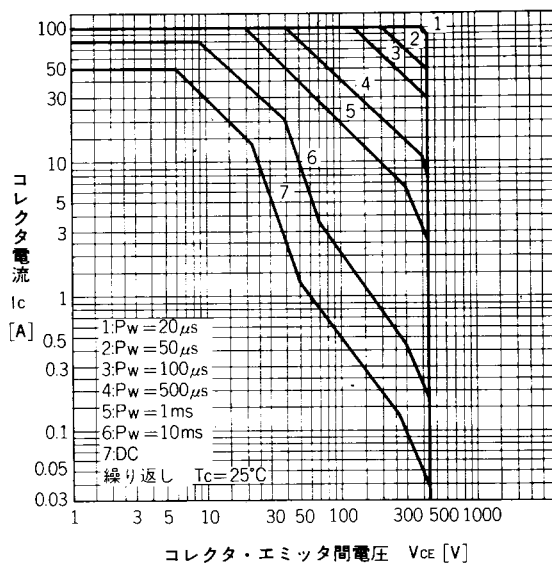

安全動作領域特性
Safe Operating Area

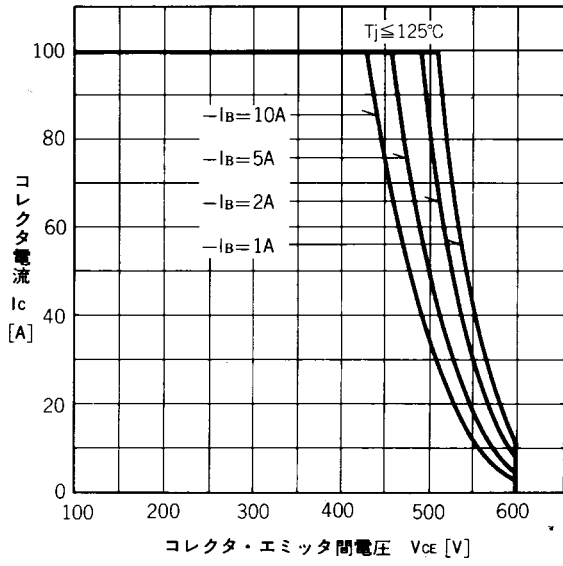

逆バイアス安全動作領域特性
Reverse Bias Safe Operating Area

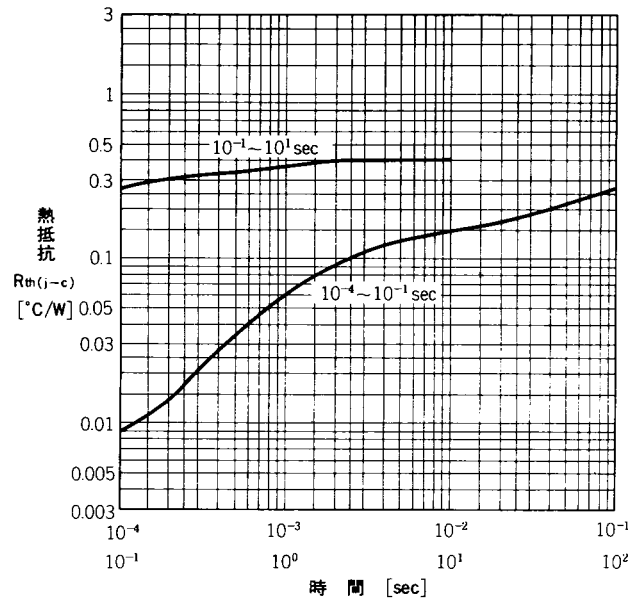

過渡熱抵抗(トランジスタ)特性
Transient Thermal Resistance(Transistor)

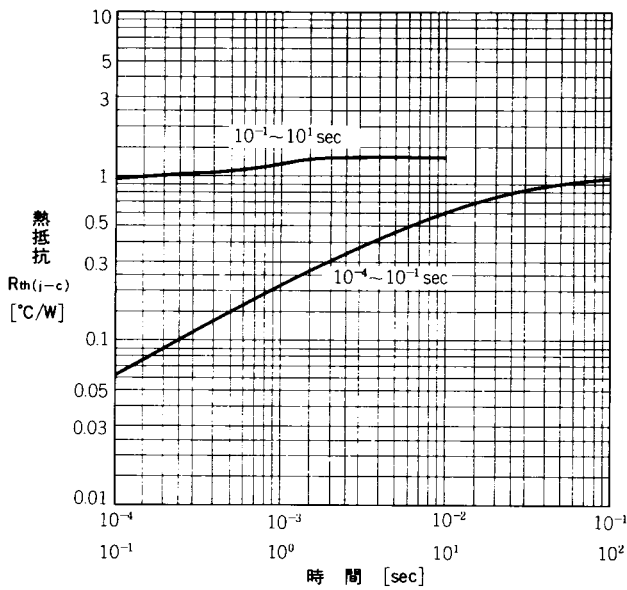

過渡熱抵抗(ダイオード)特性
Transient Thermal Resistance(Diode)

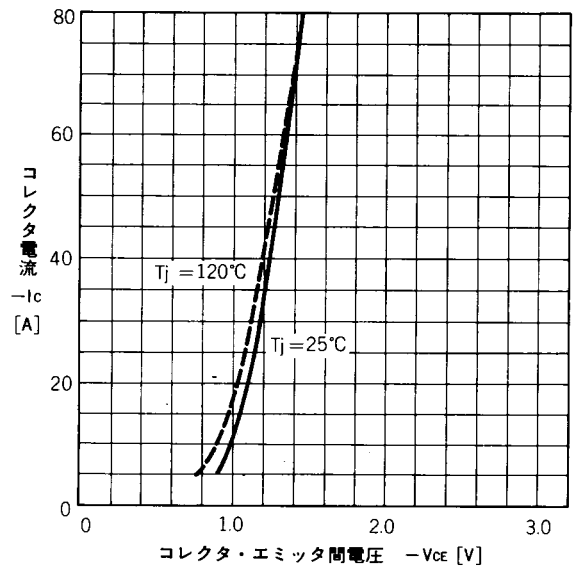

高速ダイオードの電圧降下特性
Fast Recovery Diode's Voltage

■外形寸法：Outline Drawings

